

## TYPE VEHICLE COMBINATIONS - HCT SWEDEN 25.25 TO 34 METERS



Lena Larsson  
Volvo GTT,  
Sweden  
M.sc. in  
Mechanical  
Engineering at  
Chalmers Uni of  
Tech and MBA at  
Gothenburg Uni.  
Currently Project  
manager, High  
Capacity  
Transport Vehicle  
combinations



Emil Pettersson  
ÅF Industry AB,  
Sweden  
M.sc. in  
Mechanical  
Engineering at  
Chalmers Uni of  
Tech.  
Currently  
Design Engineer;  
High Capacity  
Transport Vehicle  
combinations at  
Volvo GTT.



Niklas Fröjd  
Volvo GTT,  
Sweden  
M.sc. in  
Mechanical  
Engineering at  
Chalmers Uni of  
Tech.  
Currently  
Technology  
Specialist,  
Handling.

### Abstract

Tests with High Capacity Transport (HCT) combinations have been carried out in Sweden since 2007. The driving force for these tests has been reduction of CO<sub>2</sub> emissions, increased utilization of the infrastructure as well as transport efficiency. The allowed total weight has been up to 90 tonnes and the overall combination length has been up to 32 m, targeting 34 m.

Comparisons of stability and maneuverability has earlier been done on Swedish HCT combinations, mostly with single-track (2D) simulation models. This study used two-track (3D) modeling, able to take vehicle height into consideration, and has also put special effort in tire modeling that is fair and relevant for the comparisons.

Except for maneuverability in tight corners, many of the HCT vehicle combinations analyzed can match the current Swedish combinations that have up to 64 tonnes gross weight and 25.25 m length with respect to performance parameters. The trucks with double center-axle trailers have good maneuverability but are more critical and sensitive to load distribution with respect to dynamic performance.

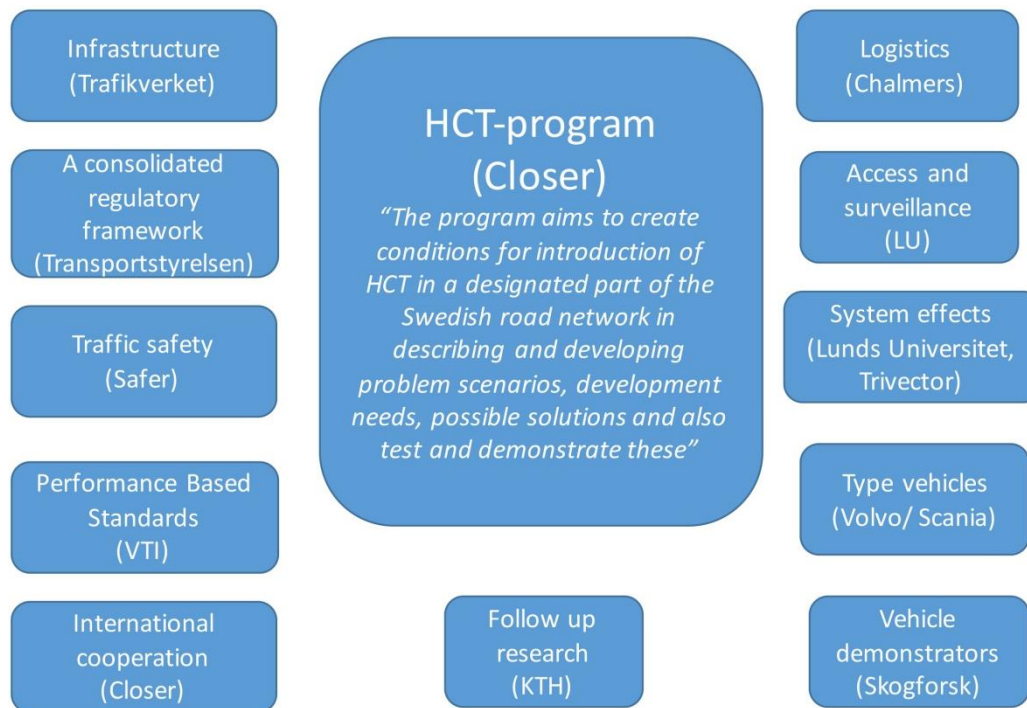
Details matter for all combinations. Over-rated single tires are good for lateral and roll over stability. Dual tires are not necessarily best as they have a narrower track and difficult to make steerable. Long wheelbases and drawbar lengths are generally good for stability. Low-speed steered axles can improve maneuverability without jeopardizing high-speed stability.

**Keywords:** High Capacity Transport, Sweden, Performance Based Standards, A-double, B-double, Truck and B-double, DUO-CAT, DUO-Trailer, Load distribution, Heavy Vehicle Truck Technology, Technical Research. Static & Dynamic Stability, Accessibility, Startability, Long combination vehicles, LCV, Heavy combination vehicles, HCV

## 1. Introduction

The first official HCT combination in Sweden was a 90 tonnes Truck and B-double timber combination (ETT - One Pile More –“En Trave Till”). The field tests started in January 2009 and results were presented at HVTT12 (Lofroth, 2012) and HVTT14 (Larsson, 2016) conferences. Another field tests started in February 2012 for transporting general cargo from Göteborg to Malmö, with one 66 tonnes double center-axle trailer combination (DUO-CAT) and one 80 tonnes A-double combination (DUO-Trailer).

In a national HCT-program, coordinated by Closer, the Volvo field test research and other vehicle demonstrators has been coordinated with other work areas. See Figure 1. The Type vehicles work area has been going on since 2014



**Figure 1 – HCT-program "work areas" 2014-2018**

The Type vehicles approach was initially used for bridge-calculations. Approximately 100 vehicles were defined briefly, from 8 m single trucks to 35 m long combinations. With this work as a base a new road class BK4 was designed allowing vehicle combinations up to 74 tonnes gross combination weight.

The work with type vehicles was expanded to include stability assessments and has been used as input to Swedish and Finnish HCT field tests applications and the Swedish Road class one and four (BK1 and BK4) legislation, which is valid from 2018. The Type vehicles work area has mainly been financed by AB Volvo, Swedish Transport Administration and FFI.

The stability requirements in the regulation above 64 tonnes is partly based on simulations, using single-track models (also called 2D-models), combined with a static roll-over calculation. Single-track models of stability and maneuverability reviews of HCT vehicle combinations have been performed in Sweden earlier, example (Aurell, 2007).

This paper describes the procedure and some result from a new analysis of a number of long 74 tonnes HCT vehicle combinations regarding dynamic stability and low speed maneuvering. The stability analysis is upgraded to two-track simulation models (also called 3D-models). It compares with current

Swedish 64-tonnes combinations within 25.25 m, and the performance characteristics are based on suggestions in the Swedish PBS (Performance Based Standards) work within the HCT-program (Kharrazi 2017). Main differences between the 3D-model and the 2D-model are that the 3D-model adds effects of center of gravity height and suspension properties, it transfers load between inner and outer wheels in curves and the vehicle can roll over.

One critical part in the vehicle simulation is to define a tire model with the appropriate complexity, able to represent the truck and trailer tires on the market. The tire model shall be as simple as possible but still relevant and fair for the comparisons of different combinations. Initially a linear tire model was used but after a while replaced with a non-linear which don't underestimate lane change off-tracking.

## **2. Method**

A model library of relevant vehicle combinations layouts was assembled from an existing Volvo 3D-model library of trucks, tractors, semi-trailers, dollies and full trailers.

Detailed designs were made of potentially efficient HCT type vehicle combinations regarding configuration, weight, axle positions loading space etc. The vehicle combinations are designed for specific applications for example: general cargo, timber, wood ship, construction and container transports. Corresponding model parameter sets were created, adding chassis properties like suspension characteristics. Reference 64 tonnes combinations were identified and parameterized.

A set of performance characteristics was defined, based on both PBS-project recommendations and the new Swedish requirements for 74 tonnes. Most of these characteristics are evaluated by simulations, but some are based on fairly simple calculations. Only stability and maneuverability is covered in this paper

Various tire modeling strategies were investigated and finally one was settled for the studies.

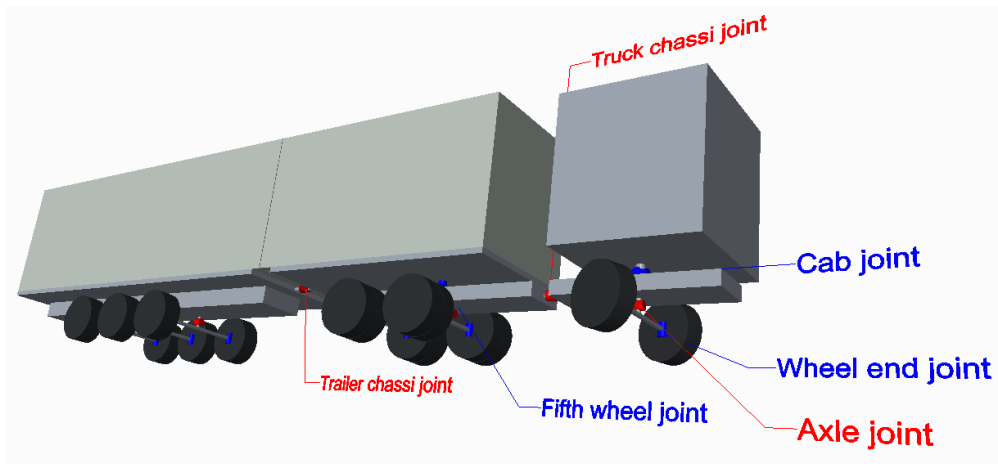
Standard parameter values for some properties were defined. When activated they override all compared type vehicles specific parameters. In this paper, there are studies on such standard parameters, as how the vehicle height or front/rear loading effect different vehicle combinations regarding stability.

All combinations were evaluated as being 4 m high and having a neutral tire parameterization. The neutral tire means all tires of the combination are regarding cornering properties scaled to the actual axle load. HCT combinations were compared with existing 64-tonnes fleet

Sensitivity studies on three of the HCT combinations were performed.

### **2.1 Simulation model**

An existing Volvo developed semi-detailed 3D-models of trucks, tractors, semi-trailers, dollies and full trailers were used as a base for the stability and maneuverability, VTM (Volvo Transport Models). This model library is based on MATLAB® and the Simulink® and Simscape™ toolboxes. In Figure 2 there is sketched layout of a tractor and semi-trailer combination demonstrating the approximate complexity of this multi-body model. The axle suspensions are suspended in roll and bounce relative to the frame. The spring and dampers are linear components. The cab suspension complexity is not needed for these simulations, but follows the standard Volvo model library. The tires are vertically suspended to the ground with linear springs, but can lift off the ground. The frame compliances of the tractor and the trailer are represented by torsional chassis joints.



**Figure 2 - sketched description of a tractor and semi-trailer 3D-model**

The parameters defining all dimensions, weights, inertias and other properties are loaded by a parameterization file. Parameter values for trucks and tractors come from typical Volvo units. For trailers and dollies they come from various sources like trailer manufacturers, trailer axle manufacturers, laboratory measurements, sub system calculations and engineering estimations.

## 2.2 Compared truck combinations

Out of the 100 defined type vehicle combinations, performances of 11 HCT vehicle combination layouts are presented in this paper. They are from 27 m to 34 m long, see Figure 3. They have a gross combination weight up to 74 tonnes. The HCT combinations are built on EMS modules and can therefore easily be taken apart o to smaller combinations, example DUO-CAT becomes an standard 18.75m combination if the last CAT is disconnected. DUO-trailer seems to be the most wanted HCT combination in Finland and Sweden. For some transport companies DUO-CAT with swap-bodies may be more suitable. MAX-VOLUME takes the lead in loading space and LONG-LINK is efficient for 40" container transports, but need some space in corners. Bright red colored axles are steered; only first axle is steered at high speed.

Three today common 64 tonnes combinations were chosen as references. They are between 23.4 m and 25.25 m long and have a maximum gross combination weight of 64 tonnes. These are the longest and heaviest combinations that are allow without special permit on Swedish roads today. Number one and two are typical general cargo transporters; the third one is a container transport.

#	Volvo name	Vehicle combination layout	Total length
1	DUO-CAT1	Double-CAT	27.3m
2	DUO-CAT2	Double-CAT	27.3m
3	DUO-CAT3	Double-CAT	27.3m
4	ETT	Truck and B-double	30m
5	MAX-VOLUME1	Truck and B-double	34m
6	MAX-VOLUME2	Truck and B-double	34m
7	DUO-TRAILER1	A-double	32m
8	DUO-TRAILER2	A-double	30m
9	DUO-TRAILER3	A-double	32m
10	DUO-TRAILER4	A-double	32m
11	LONG-LINK	B-double	30m
R1	REF1	Truck-Dolly-Semitrailer	25.25m
R2	REF2	Tractor-Semitrailer-CAT	25.25m
R3	REF3	B-double	24m

**Figure 3 - Basic layout of the HCT combinations and Swedish 64 tonnes references**

### 2.3 Load distribution

As input to the simulation model the outer boundaries of the payload and a defined payload mass are given. This is used to pre-calculate the center of gravity position for the payload and its inertia contribution. A homogenous payload box is assumed. The density is set to be the same for all units within a combination, and maximized but limited by Swedish legal axle loads and 74 tonnes (or 64 tonnes) gross vehicle weight. It means that the load density differs between the combinations.

Total load height (from the ground) is set to 4.0 m in this paper. Front and rear loading is here defined as a percentage of empty space in the rear or in the front of the load carrier. The front loading case used is 10% front loading, meaning that for instance a 13.6 m long trailer will have the load distributed evenly from the front end of the trailer but leaves the last 1.36 m loading space empty, see Figure 4. Typical general cargo transports (combinations 1, 2, 3, 5, 6, 7, R1 and R2) are designed for front loading. Timber (4), container (8, 11, R3) and wood chips (9, 10) are designed for even load and parameterized accordingly



**Figure 4 – left: even load distribution, right: 10% front loading**

### 2.4 Tire model

The concept for the vehicle combination studies was to tune the tire parameters to a standard cornering coefficient (cornering stiffness normalized by vertical load) and a standard lateral relaxation length for the nominal load of the tire. The relaxation length can be seen as a lag between slip angle and lateral force.

Parameters for the non-linear influence of vertical load and lateral are kept unchanged from a selected reference tire.

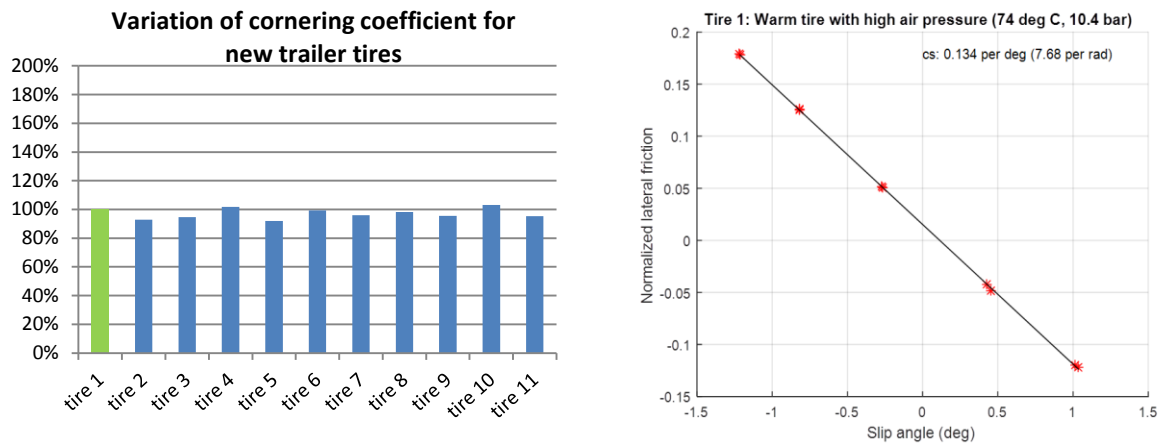
The Magic Formula 5.2 (Pacejka 2002) non-linear tire model was used as standard model. Existing parameter sets for two different 315/80 R22.5 tires obtained from two different test machines were initially compared giving similar simulation results after adjusting the cornering coefficient and relaxation to the above principles. This gave confidence in using one of this parameter sets as the reference tire parameter set for the simulations.

The standard value for cornering coefficient at nominal load was set to 7.5 g/rad, which earlier was found to give good correlation between simulations and measurements of rearward amplification of yaw velocity for a double center axle trailer combination, this combined with a relaxation length of 0.45 m. 7.5 g/rad was also found to be close to a test result for the same tire (the correlation tire) on a flat track tire testing machine at VTI in Linköping.

The tested tire could also be compared with drum test results of 10 other trailer tires. In Figure 6 with the correlation, it turned out to be a good representative. At the same time the small relative difference between the 11 tires gave confidence to the standard cornering coefficient idea. Notice that these values represent new tires. Worn down tires are known to increase in cornering stability. An representation how the work is conducted with correlation between simulation and realworld test can be seen in Figure 5.



**Figure 5 – correlation of complete vehicle performance by tuning the trailer tires cornering coefficient and relaxation.**



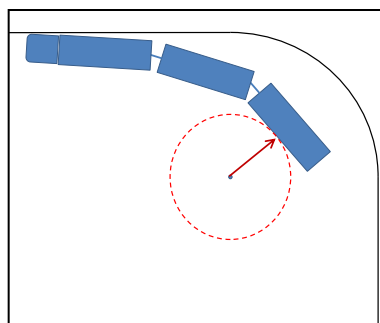
**Figure 6 – Left: drum machine testing of the correlation tire (green) and 10 other trailer tires from one tire manufacturer. Right: flat-track machine testing of the correlation tire**

The support for choosing a relaxation length of 0.45 m is also based on a general rule of thumb that it can be assumed to be equal to the tire radius. It also contributed to a good correlation to the measurements.

For the studies the nominal load for the Magic Formula parameters was either adjusted to the actual tire load for each tire in the combination (neutral tire) or to the rated vertical load for a specific tire size (sized tire). The neutral tire is used in most of the comparisons. The sized tire models are used for instance when estimating the impact of alternative tire dimensions, or when studying the effect of front and rear loading of trailers. The sized tires also effect the track and vertical stiffness of the tires. These values are estimations based on experience from various measurements.

## 2.5 Evaluated performance characteristics

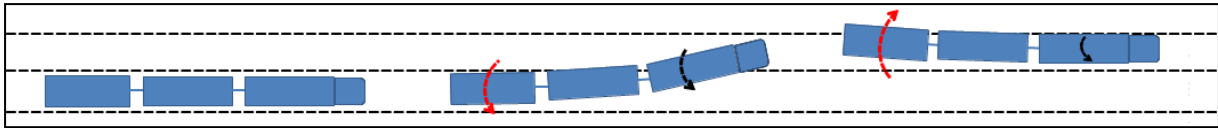
**90 degree turn inner circle radius** - Smallest inner radius at 90° turn in slow speed when the truck front corner follows a circular path with radius 12.5 m. See Figure 7.



**Figure 7 – 90° turn inner circle radius**

**90 degree turn outboard off-tracking** – Maximal outboard off-tracking of the last trailer of the truck combinations outside the 90° turn in Figure 7, including the straight lines before and after the turn.

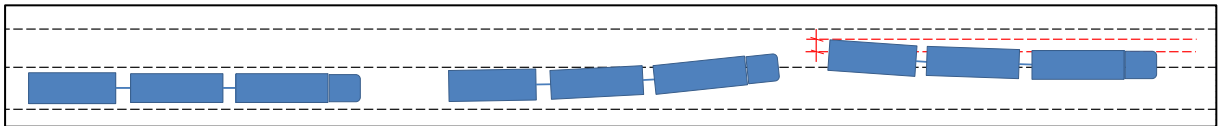
**Lane-change amplification of yaw velocity** – Maximum value of the rearward amplification of yaw velocity between the first and last vehicle unit at single sinus lane changes in a maneuver frequency range between 0,2 Hz and 0,8 Hz at 80 km/h according to ISO 14791. The lane change maneuvers has a peak acceleration of 1 m/s<sup>2</sup>. See Figure 8.



**Figure 8 – Single lane-change amplification**

**Lane-change amplification of lateral acceleration** – The same maneuver is used as for amplification of yaw velocity amplification, but instead the lateral accelerations of the truck front axle and the center of gravity of the last vehicle are compared.

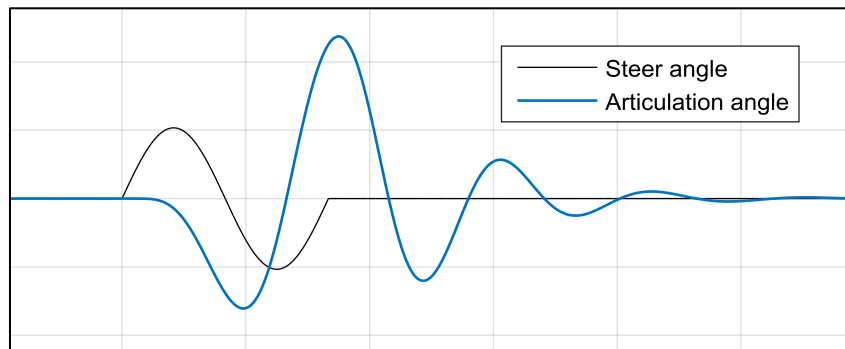
**Lane-change off-tracking** – last trailer axles lateral outboard off-tracking relatively the truck front axle at a single sinus lane change at 0.3 Hz frequency and 1.15 m/s<sup>2</sup> peak acceleration. See Figure 9.



**Figure 9 - Lane-change off-tracking**

1.15 m/s<sup>2</sup> peak acceleration is corresponding to 2 m side shift at 0.3 Hz frequency. The reason for choosing such a small side maneuver is for the comparisons of the combinations, to avoid 100% load transfer of any of the combinations.

**Articulation angle damping**– Articulation angle damping is calculated from the decay of the last articulation angle, after a single sine maneuver at 80 km/h, according to ISO 14791. A high value is preferred for the trailer to quickly stabilize after a high-speed maneuver. See Figure 10.



**Figure 10 - Articulation angle damping**

**Lane change load transfer ratio** – This percentage value represents how much vertical load is transferred to the other in the same single lane change maneuver as for lane-change off-tracking. All axles are summarized for the last units connected with fifth wheels. However the tractor front axle is not included. In Figure 11 the tires of the last axle group of a B-double have lifted, but the load transfer ratio of the combination is still not 100% as the link-trailer and the tractor still have its inner wheels on the ground.





Figure 11 – lift of the last wheels on a B-double, but the load transfer ratio is not 100%

### 3. Results highlights

#### 3.1 Rearward amplification correlation

There are two alternative measures for rearward amplification, yaw velocity and lateral acceleration. When performing measurements yaw velocity is often preferred as it is clearly easier to measure for a number of reasons, and there are probably more reference measurements to compare with. In simulations though it is as easy to capture lateral acceleration. In Figure 9 two reasons can be viewed for why lateral acceleration amplification gets more attention in this paper. It correlates better to load transfer (risk for rolling over) and lateral off-tracking.

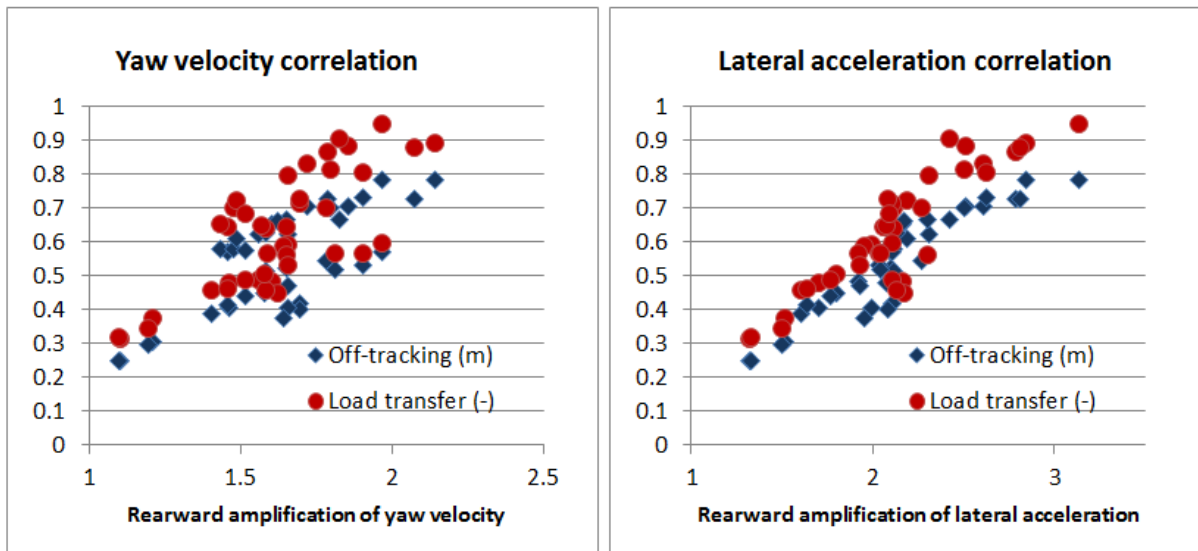


Figure 12 – Lane change amplification correlation to off-tracking and load transfer in a lane-change

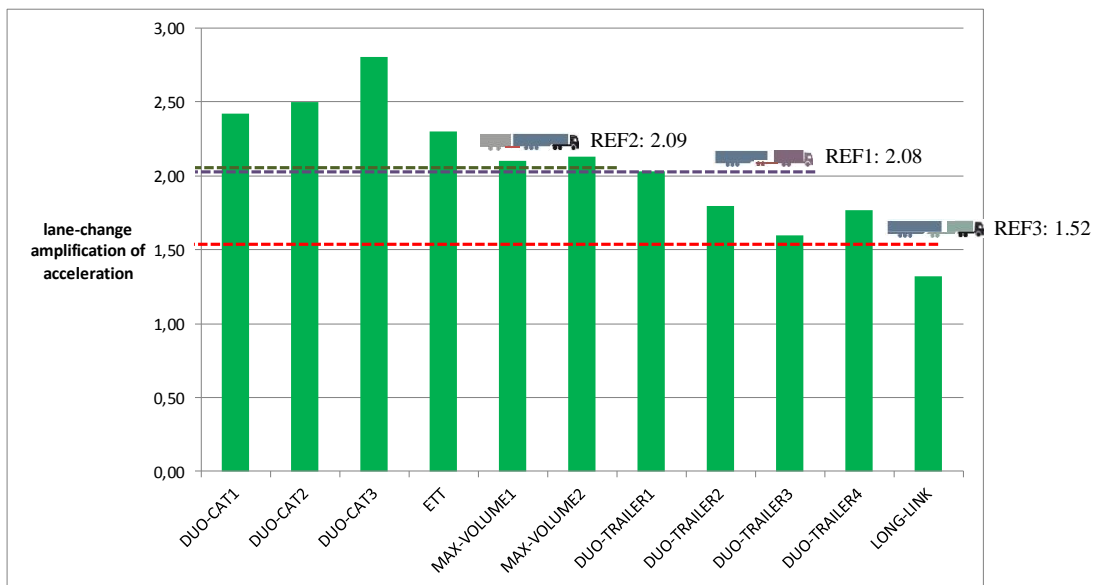
#### 3.2 Comparison between long HCT and reference 64 tonnes combinations

Eleven HCT combinations are evaluated with their standard load distribution for their intended transport application, see 2.3. They have a total length between 27.5 and 33.6 m and a gross combination weight between 64 and 74 tonnes. An overview of the stability and maneuvering results can be seen in Table 1.

**Table 1 – Performance of 64 -74 tonnes HCT combinations and 64 tonnes references**

Parameters	DUO-CAT1	DUO-CAT2	DUO-CAT3	ETT	MAX-VOLUME1	MAX-VOLUME2	DUO-TRAILER1	DUO-TRAILER2	DUO-TRAILER3	DUO-TRAILER4	LONG-LINK	REF1	REF2	REF3
Total combination weight[kg]	64096	73205	73998	73998	73956	73960	74000	70053	70002	73999	69015	63971	63995	63961
Total combination wheelbase[m]	23,43	23,89	24,67	26,29	29,30	29,40	27,60	27,05	28,95	29,55	25,30	21,14	21,07	20,20
Total combination length[m]	27,57	27,78	28,56	29,28	33,42	33,52	31,97	29,56	31,87	32,12	28,99	25,25	25,25	23,42
90 deg turn inner circle radius [m]	5,41	5,55	5,94	4,79	3,95	3,93	4,53	4,01	3,24	4,13	3,81	6,10	5,42	5,13
90 deg turn outboard off-tracking[m]	0,15	0,19	0,29	0,09	0,14	0,14	0,21	0,07	0,08	0,15	0,26	0,29	0,19	0,10
lane-change amplification of yaw-rate	1,83	1,80	2,08	1,65	1,56	1,58	1,90	1,58	1,40	1,52	1,10	1,43	1,70	1,21
lane-change amplification of acceleration	2,42	2,50	2,80	2,30	2,10	2,13	2,03	1,80	1,60	1,77	1,32	2,09	2,08	1,52
Lane-change Off-tracking[m]	0,67	0,70	0,73	0,67	0,62	0,63	0,53	0,45	0,39	0,44	0,25	0,58	0,40	0,31
Yaw damping	0,26	0,26	0,24	0,38	0,40	0,41	0,35	0,39	0,44	0,44	0,57	0,36	0,26	0,47

The comparisons are performed with neutral tire parameters and with a load height of 4.0 m for all combinations: In the bar chart summary in Figure 13 the rearward amplification of lateral acceleration is in focus. The DUO-CAT double center-axle trailer combinations are specially challenging whereas the ETT and MAX-VOLUME Truck and B-double combinations on par with a common 25.25 m Truck-Dolly-Semitrailer combination. The DUO-trailer A-doubles are within the current range of 64 tonnes combinations



**Figure 13 – Lane change amplification of acceleration (lower is better)**

In Figure 14 the space claiming in the 90° corner can be seen. Here the DUO-CAT combinations are very good, but the A-doubles are more critical. The Long-Link combination has steered last axle of both the link and semitrailer. DUO-trailer 4 also has such trailer steering. It is clear that the longest HCT combinations require extra space.

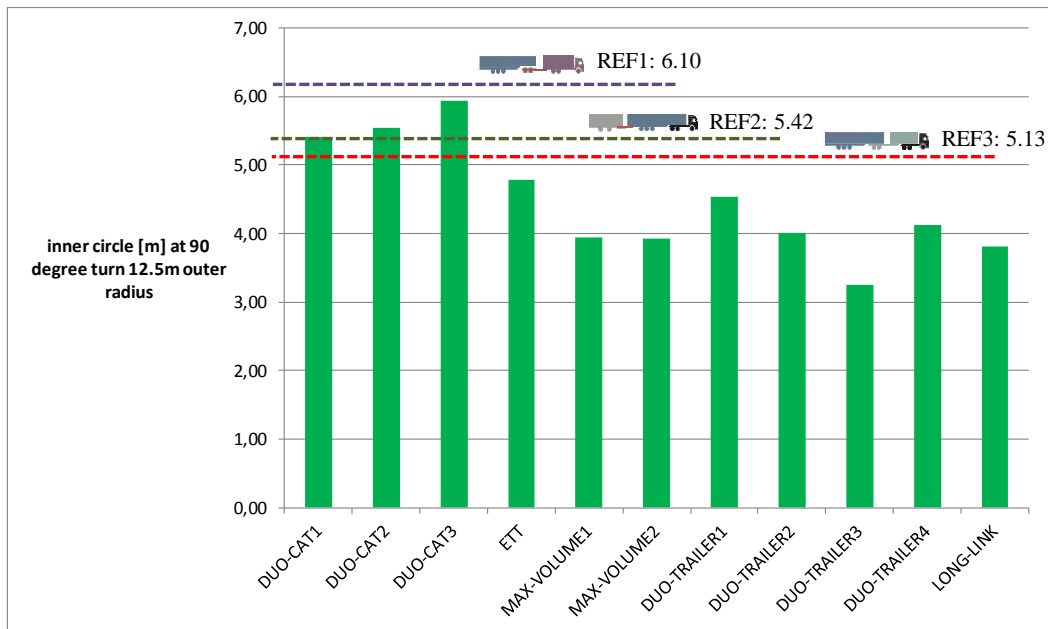


Figure 14 – Inner radius [m] at 90° turn with 12.5m outer radius [higher is better]

### 3.3 Comparing different tire sizes

As the cornering coefficient normally increase somewhat when a tires carry less load and vice versa, there is a possibility to increase the lateral combination stability by mounting over-rated tires in relation to the actual axle load, see Figure 15. Dual tires are often over-rated. On the other hand the roll stability must be taken into account (see **Figure 15**), therefore also track and vertical stiffness are important. Following tire sizes, with corresponding estimated track and vertical stiffness are compared:

385/55 R22.5 – single	track 2.10 m	rated 4.5 t/tire	stiffness 1300 N/mm/tire
265/70 R19.5 – twin	track 1.95 m	rated 2.575 t/tire	stiffness 800 N/mm/tire
275/70 R22.5 – twin	track 1.90 m	rated 2.9 t/tire	stiffness 900 N/mm/tire
315/70 R22.5 – twin	track 1.85 m	rated 3.75 t/tire	stiffness 1000 N/mm/tire

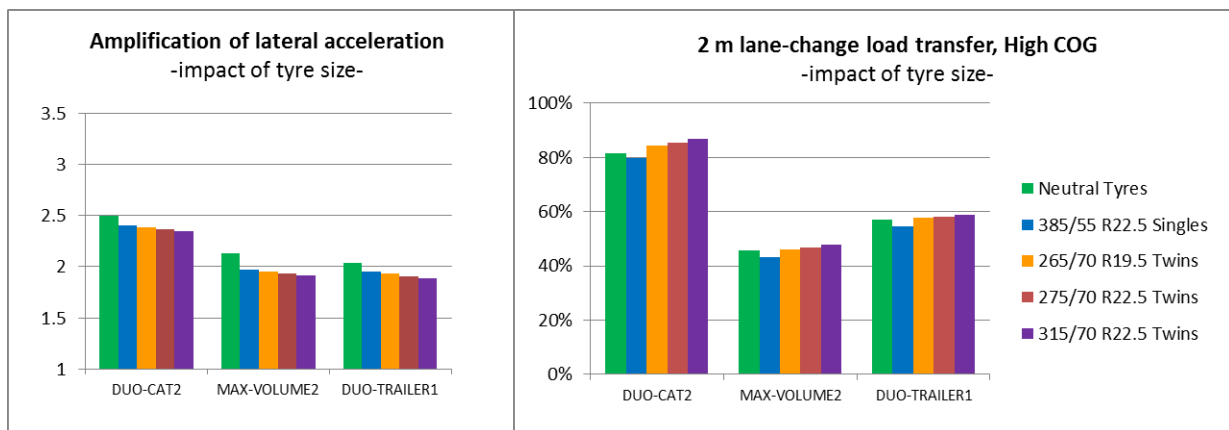


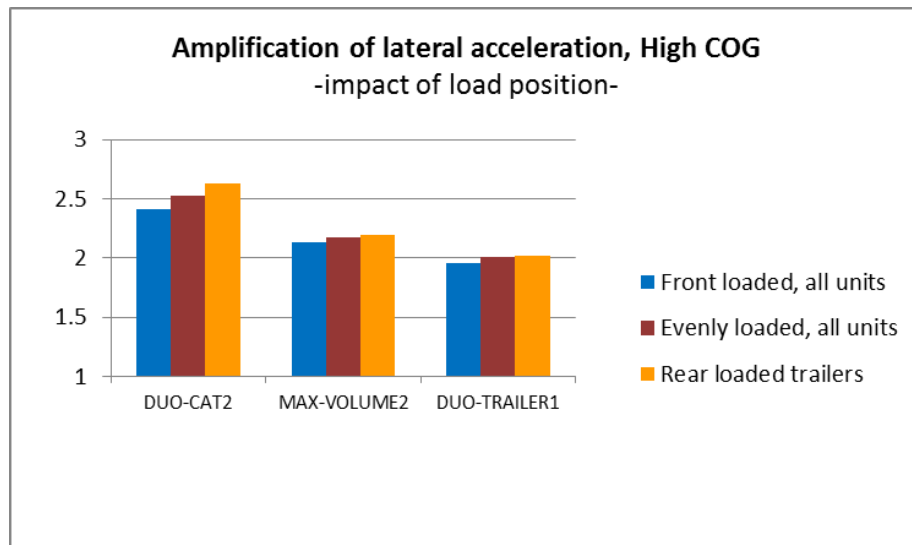
Figure 15 – Amplification of lateral acceleration and lateral load transfer for different size tire.

To be notice is that despite the improvement in rearward amplification with higher tire rating the load transfer actually increases. It is most probably caused by the dual mounted tires more narrow track.

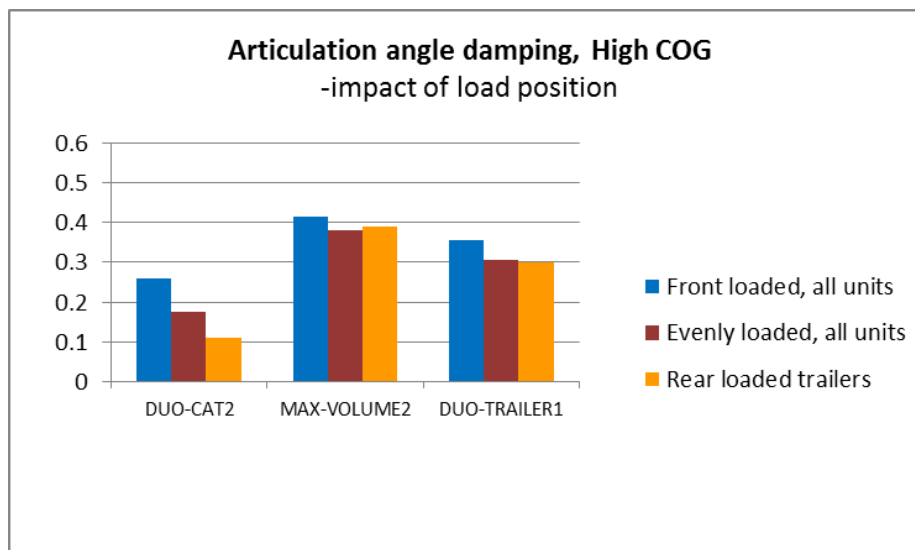
### 3.4 Sensitivity to load distribution

As the three HCT-combinations chosen for special studies are designed for general cargo applications it is meaningful to investigate their sensitivity to varying load distribution. In reality the center of gravity position longitudinally can vary quite much for this study one specific tire size was chosen, single 385/55 R22.5, for all loading cases. The neutral tire is less relevant here as it would adapt completely to the axle load

Most noticeable is the articulation angle damping drop when going from front loading to even load distribution. For the double CAT trailer combination, having quite low damping from the beginning, the even load distribution is starting getting critical. See Figure 16 and Figure 17.

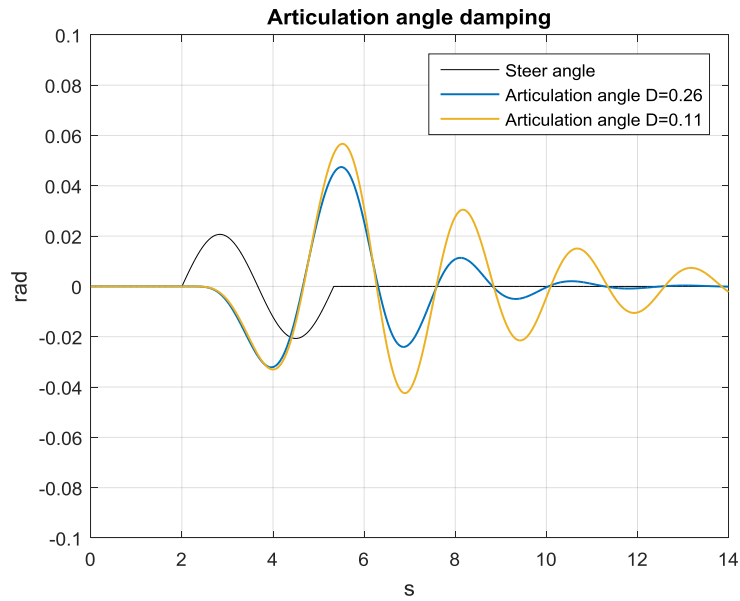


**Figure 16 – lateral acceleration sensibility from loading position**



**Figure 17 – articulation angle damping sensibility from loading position**

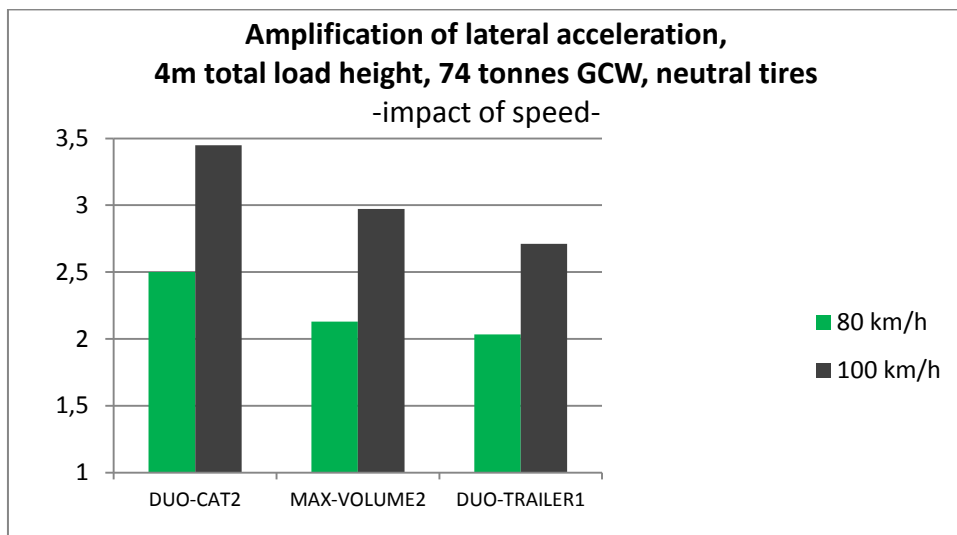
To get a feeling for what this drop means Figure 18 illustrates the time history of the articulation angle when the articulation angle damping is 0.26 and 0.11 respectively



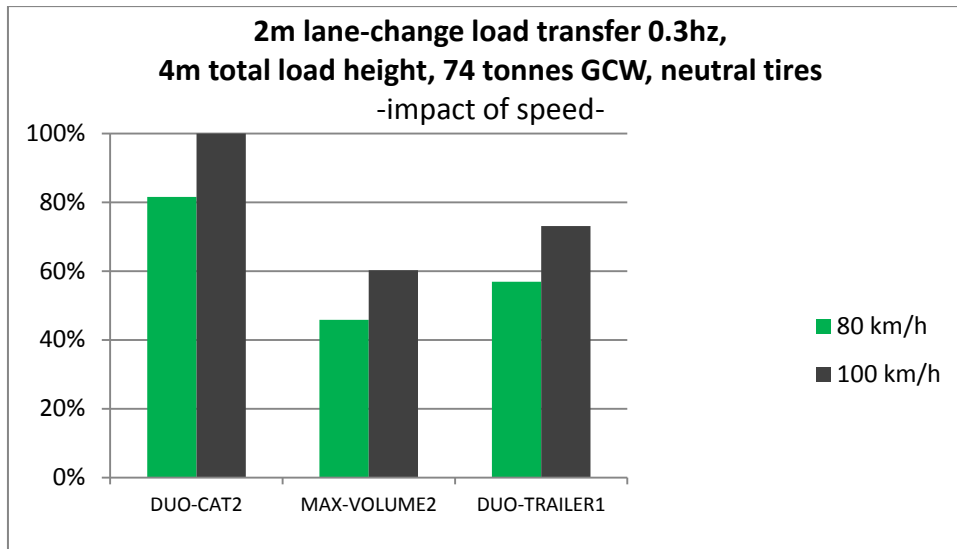
**Figure 18 – Visualization of articulation angle damping of 0.26 and 0.11 values**

### 3.5 Sensitivity to speed

Maximum allowed speed for these combinations is 80 km/h in Europe. The relevant speed for high speed characterization is set to 80 km/h, but still there is a possibility that, at least occasionally, the combinations will come up in higher speed, in long down hills for instance. The rearward amplification increases drastically as can be seen in Figure 19 and Figure 20.



**Figure 19 – Amplification of lateral acceleration, sensibility for speed**



**Figure 20 – Load transfer, sensibility for speed**

It is clear that speed increases the amplification effects, but that the ranking between the combinations seems consistent.

#### 4. Conclusions & Discussion

With 3D simulations roll and lateral performance can be assessed in the same simulation. Here pros and cons could be evaluated regarding single and dual mounted tires for instance. The twin mounted tire has a better lateral stability, but a narrower track, which is negative for roll stability. With 3D-models there is also a possibility to determine if a low center of gravity combination can accept a higher gross combination weight.

The strategy using completely neutral tire models is fair for comparing combination layouts in most cases, but still it can be a bit misleading in some cases, especially for combinations having more axles than needed for the actual gross combination weight. This might be the case when designing a combination which should be insensitive to varying load distribution. The alternative sized tire parameterization can be specially suited here. It should also be mentioned that both the neutral and sized tire model parameters are representing new tires, which is the worst case. When tires wear down they normal increase in stability, meaning the vehicle stability gets better. The cornering stability can increase 30% which has a large effect. It can also be estimated in the modeling but left out here due to space.

The initial idea to use linear tires are perhaps not sufficient, but a non-linear model can probably be simpler and need less parameters, than the Magic Formula used here.

5<sup>th</sup> wheels and drawbar couplings has to be studied further.

Rules and regulations based on performance parameters are recommended to be specified with what simulation method that is used.

The extensive simulations and tests of up to 34m and 90 tonnes combinations, shows that these heavier and or longer combinations can be built and used in a way that makes them just as safe as the standard combinations today, but it may require more insight in details, perhaps access to simulation tools, max-speed controller, special loading instructions etc. Inappropriate loading, tires and dimensions such as wheelbase of trailer and coupling distances may however ruin the stability, but this can happen today as well.

## 5. References

- Lofroth, C., Larsson, L., Enstrom, J., Cider, L., Svenson, G., Aurell, J., Johansson, A. and Asp, T., (2012), “ETT – A Modular System for Forest Transport A three-year roundwood haulage test in Sweden”, HVTT12
- Larsson, L., Cider, L. and Pettersson, E., (2016), “CO-optimizing multi vehicle combinations, fuel consumption & traction in slippery condition”, HVTT14
- Aurell, J. and Wadman, T. (2007), “Vehicle combinations based on the modular Concept”, NVF Report 2007/1
- Kharrazi, S., (2016), “Performance of high capacity vehicles winter versus summer”, HVTT14
- Pacejka, Tyre and Vehicle Dynamics, 2002, Butterworth-Heinemann, ISBN 0 7506 5141 5.
- ISO 14791 Road vehicles – Heavy commercial vehicle combinations and articulated buses – lateral stability test methods
- Kharrazi, S., Karlsson, R., Sandin, J., and Aurell J. (2015), “Performance based standards for high capacity transports in Sweden”, - Report 1 , Review of existing regulations and literature
- Kharrazi, S., Bruzelius, F. and Sandberg U. (2017), “Performance based standards for high capacity transports in Sweden”, - Final Report

## 6. Abbreviations

PBS	Performance Based Standards
ETT	One Pile More ( <u>E</u> n <u>T</u> rave <u>T</u> ill)
VTM	Volvo Transport Models (AB Volvo Program)
GTT	<u>G</u> roup <u>T</u> ruck <u>T</u> echnology
HCT	<u>H</u> igh <u>C</u> apacity <u>T</u> ransport
PBS-project	PBS-project within HCT-program, see Figure 1
BK1-4	Road <u>B</u> earing <u>C</u> lasses in Sweden
EMS	European Modular System according to 96/53/EC
VTI	Swedish National Road and Transport Research Institute
2D-model	single-track simulation model, two dimensions
3D-model	two-track simulation model, three dimensions